

Divisione in 7 parti uguali
del lato corto di un rettangolo

1

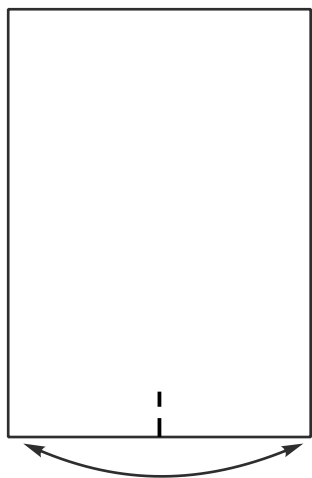

2

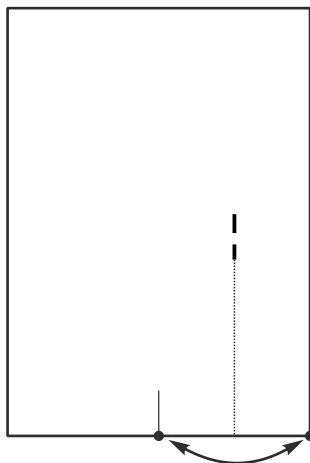

3

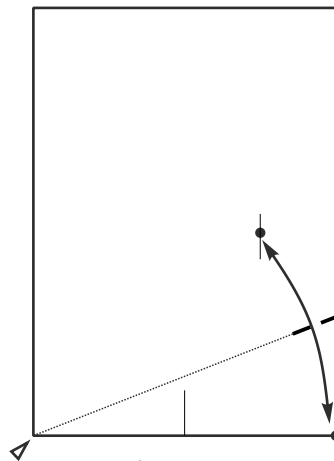

5

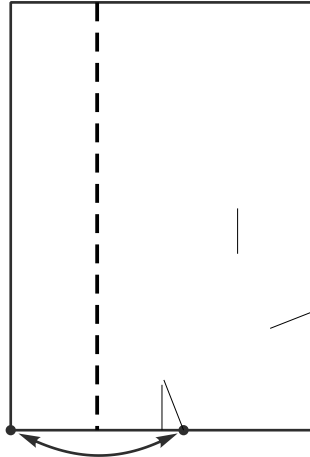

4

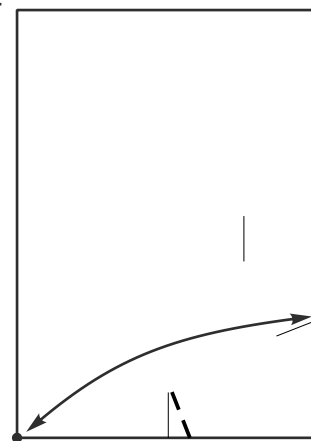

6

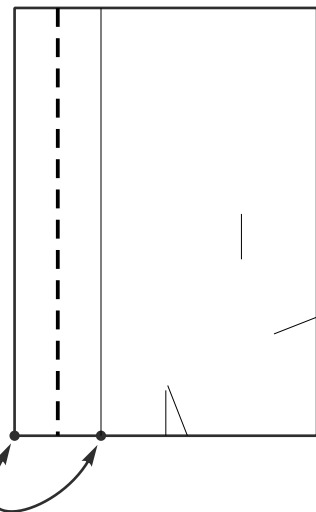

7

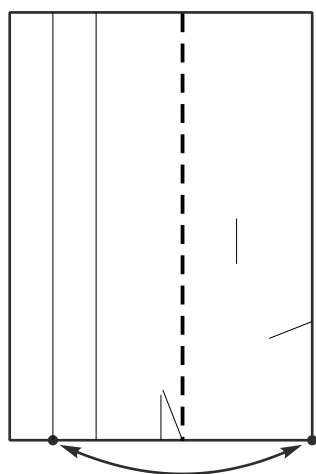

8

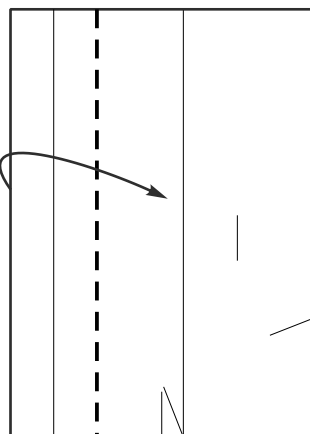

9

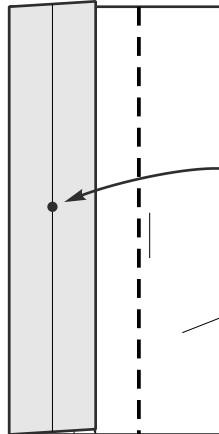

10

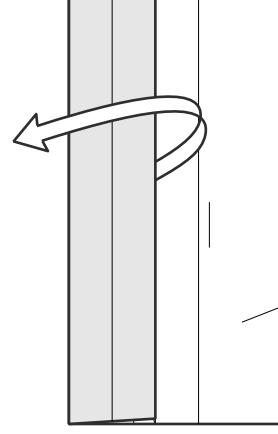

11

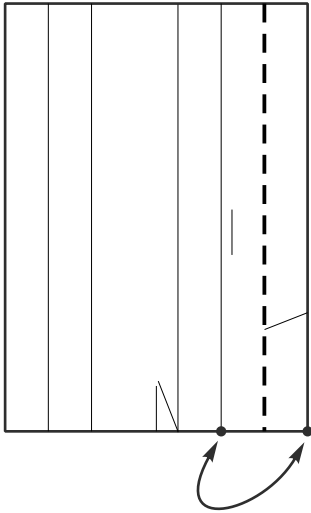

12

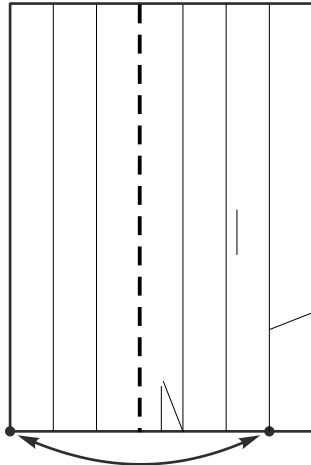

13

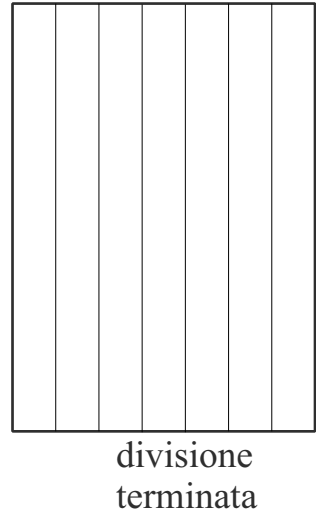

Divisione in 7 parti uguali
del lato lungo di un rettangolo

1

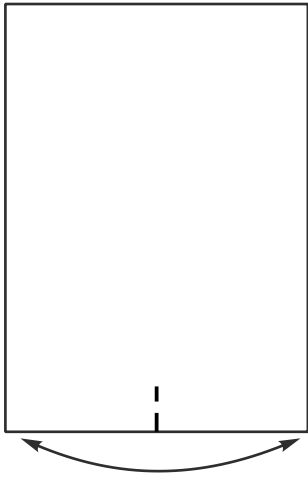

2

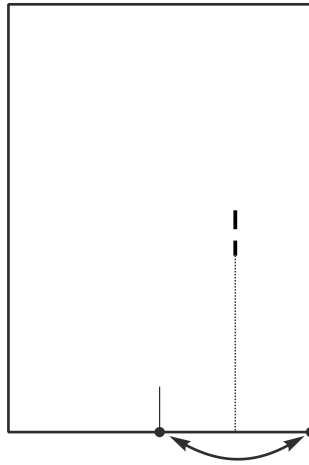

3

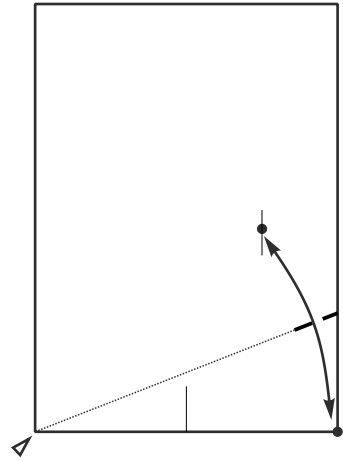

4

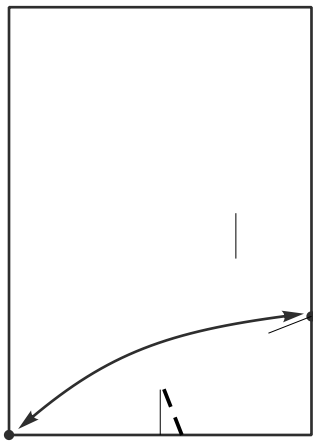

5

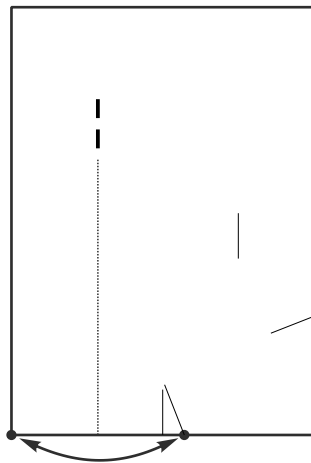

6

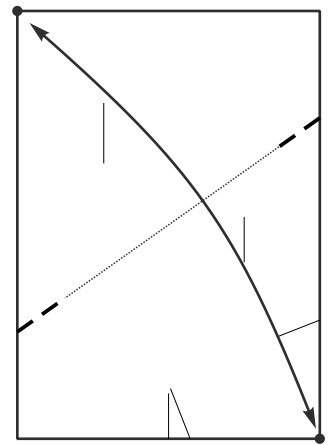

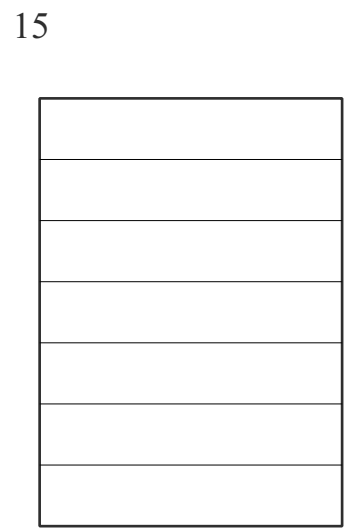
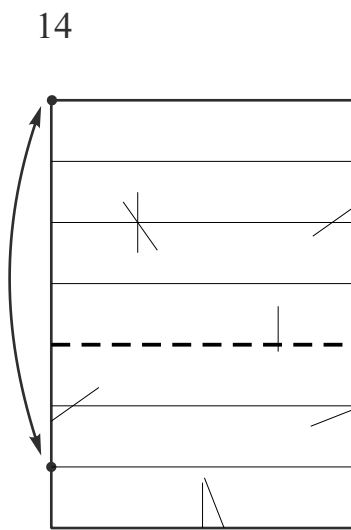
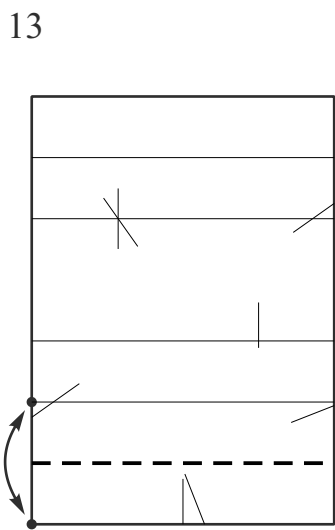
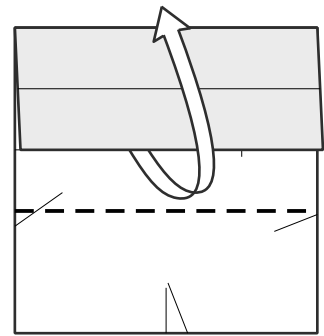
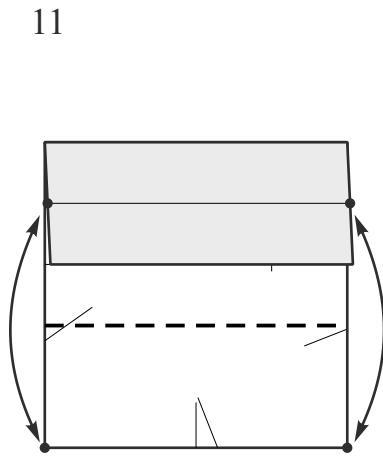
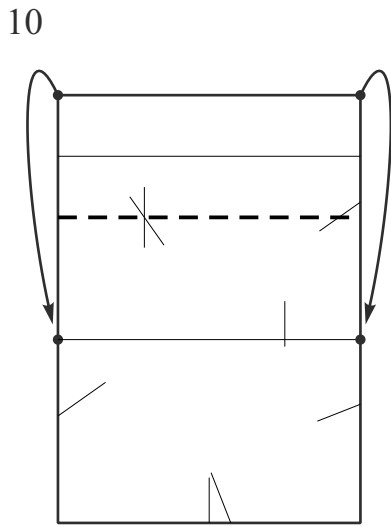
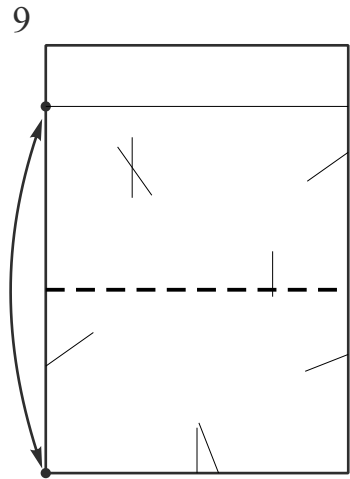
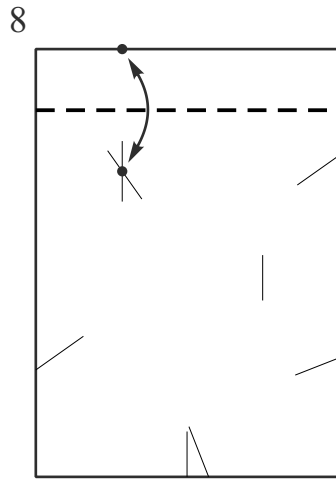
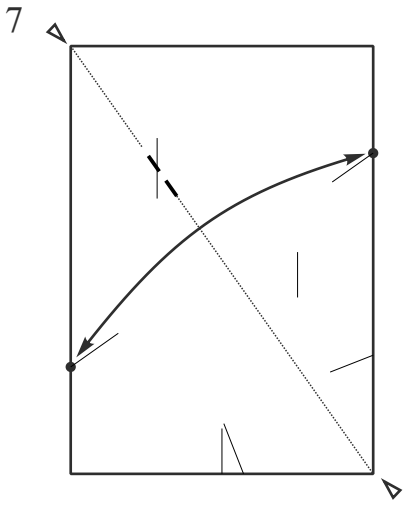

Divisione
terminata